

VENETIAN BLINDS BASSWOOD, BAMBOO, LIGHTWOOD

25, 50 & 63 mm



• Utföranden av lamellbredder och stegar



ÖVERLIST 21

Här visad med Täcklist A
Info om täcklister finns på s.4

25 mm

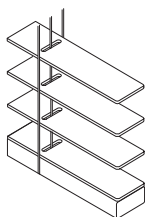

25 mm lamellbredd
med stegsnöre

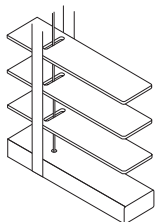

25 mm lamellbredd
med 13 mm stegband



ÖVERLIST 31

Här visad med Täcklist A
Info om täcklister finns på s.4

50 mm

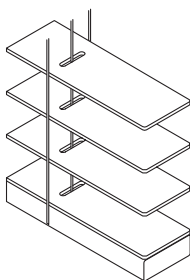

50 mm lamellbredd
med stegsnöre

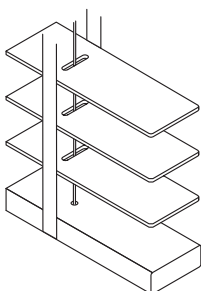

50 mm lamellbredd
med 10 mm stegband

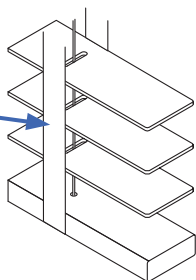

50 mm lamellbredd
med 24 mm stegband

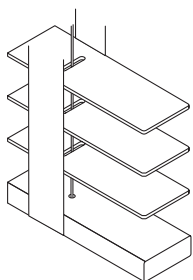

50 mm lamellbredd
med 38 mm stegband

63/65 mm

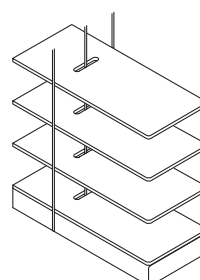

63/65 mm lamellbredd
med stegsnöre

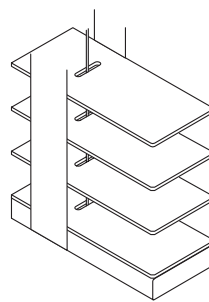

63/65 mm lamellbredd
med 38 mm stegband



• Utföranden av överlister och beslag

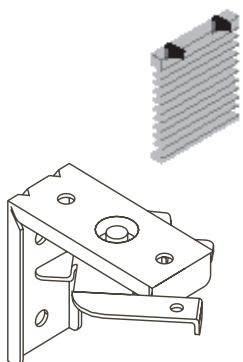

Universalbeslag
(Metallfärgat)



ÖVERLIST 21
Här visad med Täcklist B
Info om täcklister finns på s.4

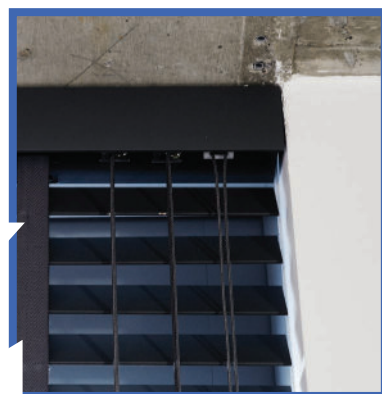

ÖVERLIST 31
Här visad med Täcklist A
Info om täcklister finns på s.4

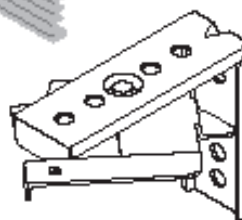

Universalbeslag
(Metallfärgat)

VAJERSTYRNING

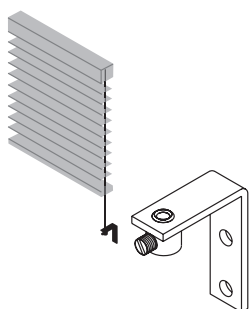
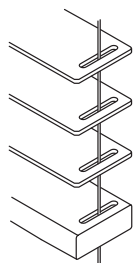

Vajerbeslag för väggmontage
25 & 50 mm lamellbredd
Metallfärgat eller vitlackat

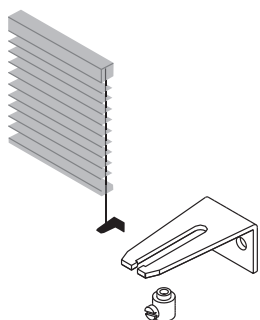

Vajerbeslag för väggmontage
63/65 mm lamellbredd
Metallfärgat

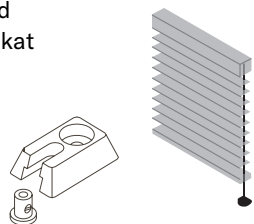

Beslag för Nischmontage
i transparent plast

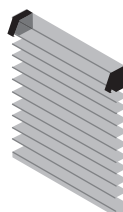

Gavelbeslag*

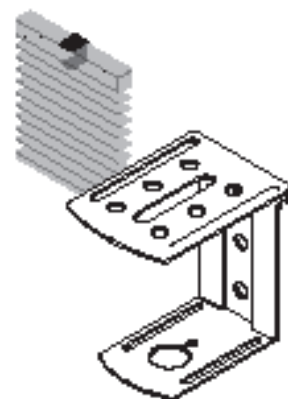

Mittstöd*

* Då persienn överstiger 1200 mm bredd så används mittstöd i kombination med gavelbeslag. Beslagen lackas enligt överlistfärg.

MOTORISERING



Vi erbjuder olika typer av motorer och styrningar till överlist 31

• Mått

ÖVERLIST NR. 21
med 25 mm lamell

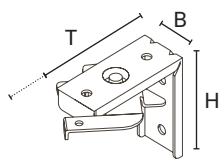

Universalbeslag

B 19 mm
T 47 - 62 mm
H 44 mm

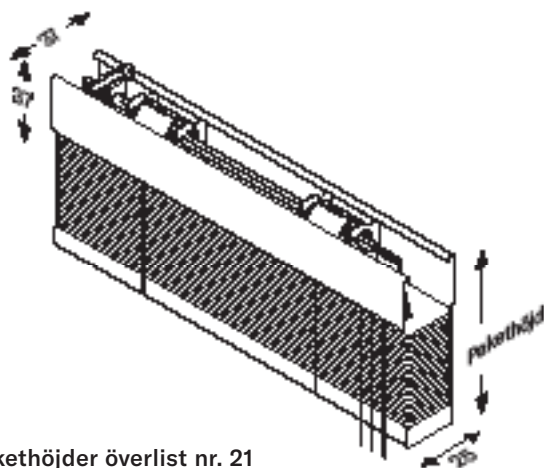

Pakethöjder överlist nr. 21

Lamell	Stegsnöre, Stegband	Persiennhöjd i mm				
		1000	1500	2000	2500	3000
Basswood 25 mm	2 mm	205	280	360	440	520
	13 mm	220	305	385	470	555

Täcklist typ A

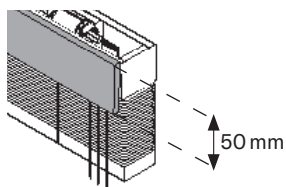

Täcklist typ B

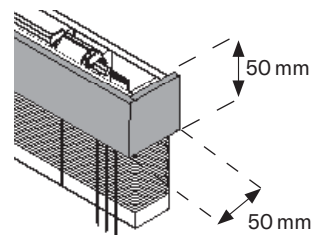

Täcklist B är 25 mm
bredare än persiennen

ÖVERLIST NR. 31
med 50, 63/65 mm lamell

Pakethöjder Überlist nr. 31

Lamell	Stegsnöre, Stegband	Persiennhöjd i mm				
		1000	1500	2000	2500	3000
Bamboo 50 mm	2 mm	130	155	185	215	245
	10, 24, 38 mm	145	175	210	245	280
Basswood & Lightwood 50 mm	2 mm	150	190	230	265	305
	10, 24, 38 mm	175	230	280	335	390
Basswood 65 & Lightwood 63 mm	2 mm	135	165	200	225	255
	38 mm	165	200	235	270	305

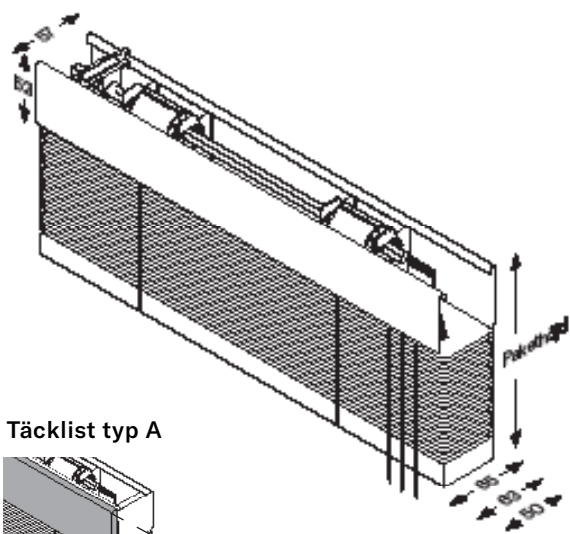

Täcklist typ A

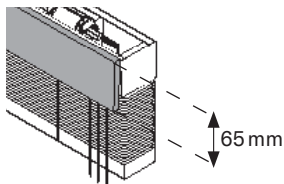

Täcklist typ B

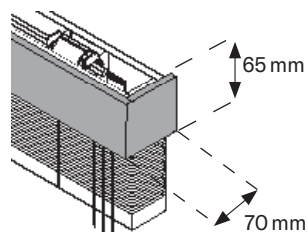

Täcklist B är 35 mm
bredare än persiennen

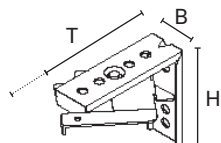

Universalbeslag

B 19 mm
T 64 - 80 mm
H 55 mm

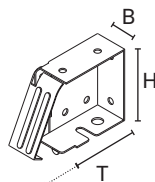

Gavelbeslag

B 26 mm
T 63 - 105 mm
H 58 mm

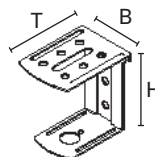

Mittstöd

B 40 mm
T 55 mm
H 58 mm

VAJERSTYRNINGSBESLAG

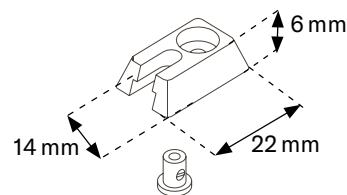

Vajerbeslag för nischmontage

Typ 2

B 12 mm
T 27 mm
H 37 mm

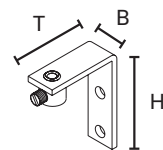

Typ 3

B 24 mm
T 50 mm
H 21 mm

